

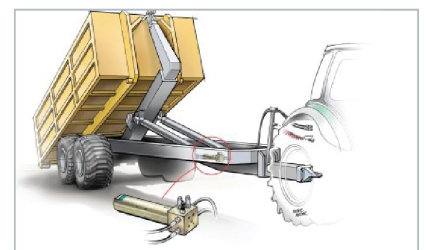

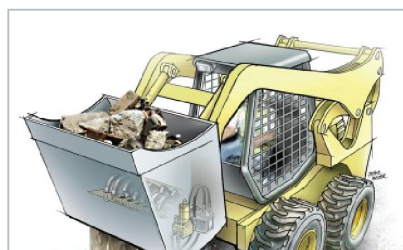

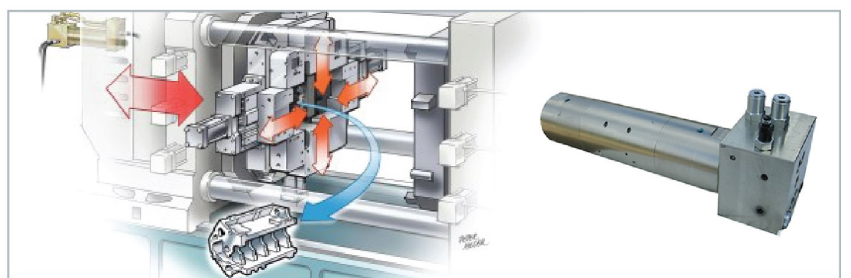

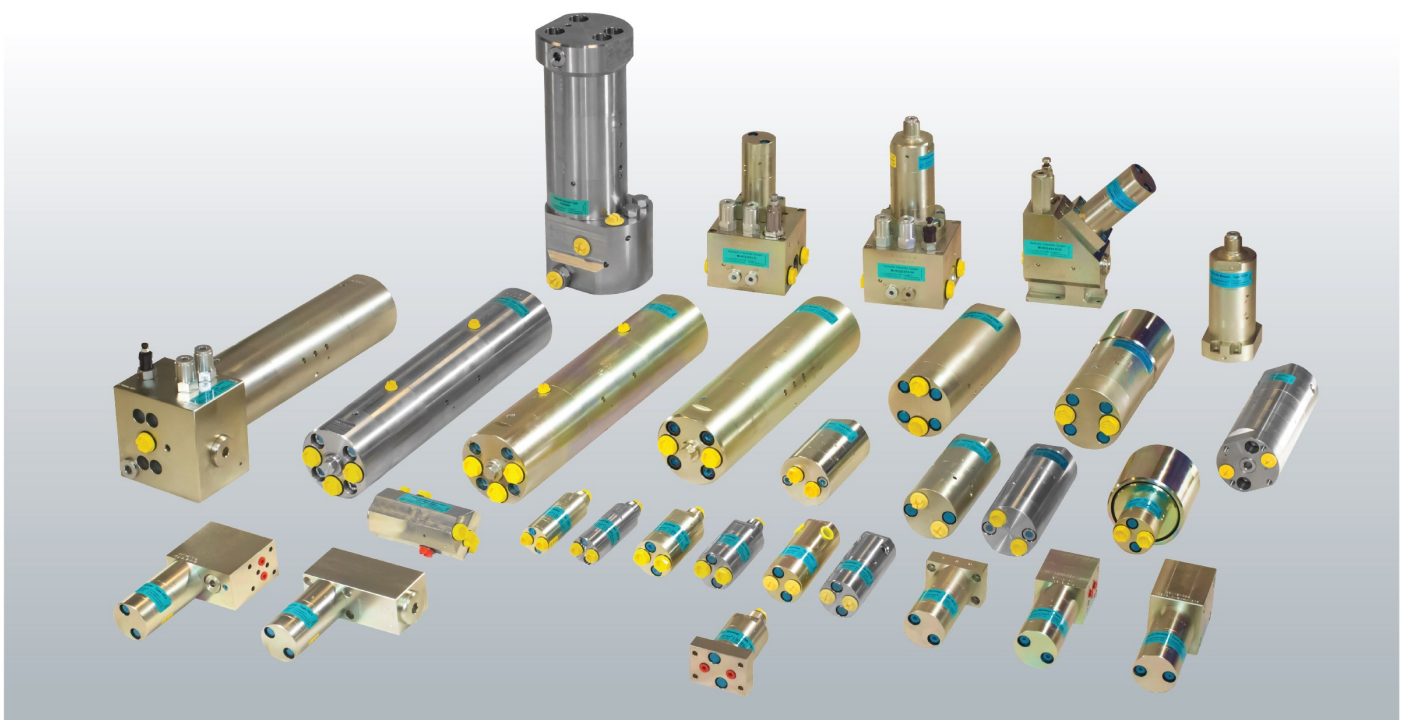

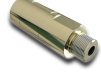
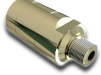
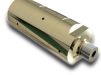

The only full range of hydraulic intensifying solutions

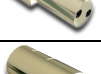
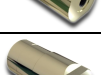
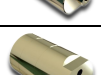
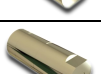

MINIMUM SIZE – MAXIMUM POWER

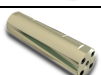
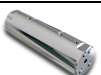
Our wide product range covers your needs

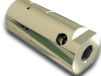
For almost any fluid media, simply specify your needs for outlet pressure up to 5000 bar and inlet flow up to 70 l/min, You will easily find the optimal hydraulic intensifier in the table below.

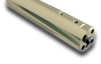
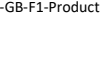
Outlet Pressure bar	Average outlet flow (l/min)	Inlet pressure (bar)	Inlet flow (l/min)	Connection	Weight (kg)	Ratio	Model: Steel	Model: Stainless steel	Comments	Models
24 - 800	0.3 - 0.5	20 - 207	2.0 - 8.0	<ul style="list-style-type: none"> • Tube • Flange • Cartridge 	0.7	1.2 - 7.5	HC1	HC1W		
24 - 800	0.3 - 2.5	20 - 207	2.0 - 15.0	<ul style="list-style-type: none"> • Tube • Flange • Cartridge 	1.0	1.2 - 20.0	HC2	HC2W		
24 - 800	0.7 - 11.0	20 - 207	2.0 - 15.0	<ul style="list-style-type: none"> • Tube • Flange 	3.8	1.2 - 20.0	HC2D	HC2DW		
80 - 1380	1.5 - 5.0	20 - 207	2.0 - 14.0	<ul style="list-style-type: none"> • Tube • Flange 	8.0	4.0 - 13.0		HC2DHW		
20 - 800	2.0 - 3.0	20 - 207	2.0 - 15.0	<ul style="list-style-type: none"> • Tube • Flange 	4.15	1.0 - 10.1	HC2D2	HC2D2W	2-media	
80 - 1380	0.6 - 1.6	20 - 207	2.0 - 8.0	<ul style="list-style-type: none"> • Tube • Flange 	8.0	4.0 - 12.0		HC2D2HW	2-media	
24 - 500	0.3 - 2.5	20 - 207	2.0 - 15.0	<ul style="list-style-type: none"> • Flange • Cartridge 	2.5	1.2 - 20.0	HC3	HC3W		
26 - 800	1.5 - 7.0	20 - 207	2.0 - 35.0	<ul style="list-style-type: none"> • Tube • Flange 	3.7	1.3 - 9.8	HC4	HC4W		
100 - 3000	1.2 - 3.5	20 - 207	2.0 - 38.0	<ul style="list-style-type: none"> • Tube • Flange 	4.0	5.1 - 17.3	HC4H			
24 - 800	0.3 - 2.5	20 - 207	2.0 - 15.0	<ul style="list-style-type: none"> • Tube • Flange 	3.0	1.2 - 20.0	HC5		Double-acting	
26 - 800	2.5 - 15.0	20 - 207	5.0 - 70.0	<ul style="list-style-type: none"> • Tube • Flange 	9.5	1.3 - 8.2	HC6			
124 - 5000	1.0 - 7.0	20 - 207	5.0 - 50.0	<ul style="list-style-type: none"> • Tube • Flange 	11.0	6.2 - 25.0	HC6H			
24 - 800	11.2 - 56.0	20 - 207	5.0 - 70.0	<ul style="list-style-type: none"> • Tube • Flange 	20.0	1.2 - 8.2	HC6D	HC6DW		
80 - 1380	3.0 - 12.5	20 - 207	5.0 - 50.0	<ul style="list-style-type: none"> • Tube • Flange 	35.0	4.0 - 16.0		HC6DHW		
20 - 800	6.0 - 41.0	20 - 207	5.0 - 70.0	<ul style="list-style-type: none"> • Tube • Flange 	22.0	1.0 - 10.1	HC6D2	HC6D2W	2-media	
100 - 2000	0.3 - 1.6	20 - 207	2.0 - 14.0	<ul style="list-style-type: none"> • Tube • Flange • Cartridge 	1.5	5.0 - 20.0	HC7	HC7W		
100 - 2000	0.3 - 1.6	20 - 207	2.0 - 14.0	<ul style="list-style-type: none"> • Tube • Flange • Cartridge 	5.0	5.0 - 20.0	HC8			
220 - 5000	0.3 - 1.8	20 - 207	5.0 - 20.0	<ul style="list-style-type: none"> • Tube • Flange 	9.9	8.2 - 25.0	HC9			
20 - 1380	2.0 - 5.6	20 - 207	5.0 - 30.0	<ul style="list-style-type: none"> • Tube • Flange 	25.0	5.2 - 15.0	HC9D2	HC9D2W	2-media	

Intensifier systems

miniBOOSTER carries a wide range of intensifier systems that provides “plug-and-play” solutions for your applications. The systems protect the high-pressure tools and provide a high bypass flow, which speeds up your process.



Intensifiers with integrated control valves

The HC22, 25, 72 and 75 provides a compact integration of a control valve and a intensifier that easily can be mounted in your equipment securing speed and protection of both intensifier and tooling.

Key benefit features are:

- 11 different intensification outlets
- An optional orifice to reduce inlet flow
- Weight is only 2.3 kg
- Available in stainless steel
- HC22 with adjustable outlet pressure - max 800 bar
- HC25 for fast forward movement - max 800 bar
- HC72 with adjustable outlet pressure - max 2000 bar
- HC75 for fast forward movement - max 2000 bar

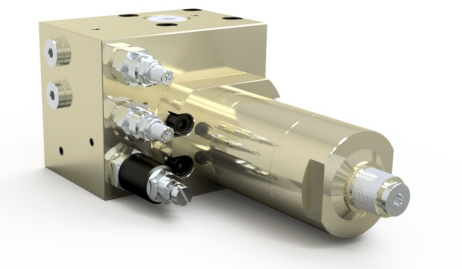

Intensifier systems with high bypass flow

The M-HC intensifier systems provide high bypass flow and pressure on demand, designed to boost the system pressure when needed and only when high pressure is required.

Key benefit features are:

- Pressure on demand
- Solenoid-activated or automatically activated
- High pressure - up to 700 bar (10,000 psi)
- Fast fill - system flows up to 400 L/min
- Inlet pressure up to 350 bar
- Extended service life
- Robust and flexible design, several intensifications ratios
- Tube or flange connection

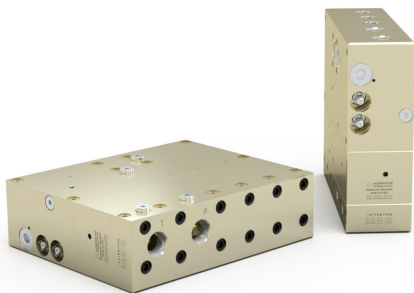

Portable intensifier systems

The M-HC7 portable intensifier system is a rugged unit designed for demanding industrial applications. The M-HC7 can be used with any power source providing a minimum of 20 bar and 2 L/min.

Key benefit features are:



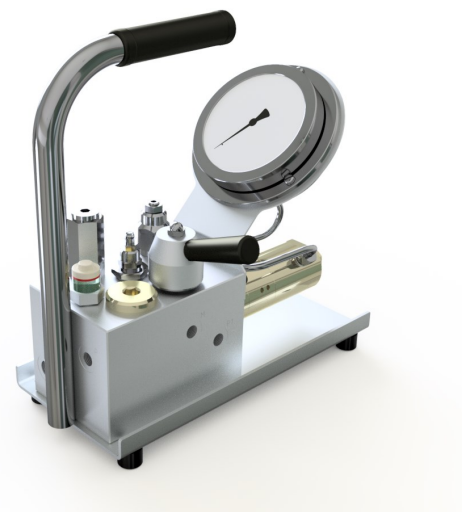

- Output flow up to 15 L/min
- 30 L/min with Twin Intensifier
- High pressure up to 2000 bar
- No additional utilities are required
- Weight is only 10 kg - easily carried where it is needed
- Easy-to-read 4" diameter gauge keeps pressure setting within 1% of target.





Other products

miniBOOSTER products carry a wide range of filters, valve housings, cartridge valves and accessories.



Filters

Steel	Stainless steel	Models
In-Line Filter		
High Pressure T-filter	FILW HT-10-1	
T-filter		
Filter Housing		
NG6 Filter		

Accessories

Mixed Material	Models
Adapter Kits	
Adapters	
Pilot Operated Check Valves	

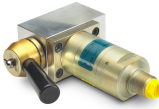
Valve Housing

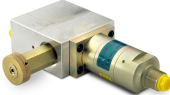
Steel	Stainless steel	Models
CV1	CV1W	
CV2	CV2W	
CV3	CV3W	
CV4	CV4W	
CV5	CV5W	